







## Potential of microbial protein from hydrogen for preventing mass starvation in catastrophic scenarios

Authors: Juan B. García Martínez<sup>A\*</sup> , Joseph Egbejimba<sup>A,B</sup>, James Throup<sup>A</sup>, Silvio Matassa<sup>C</sup> , Joshua M. Pearce<sup>A,D</sup> , David C. Denkenberger<sup>A,B</sup> 

\*Corresponding Author. Contact at: [juan@allfed.info](mailto:juan@allfed.info).

Affiliations:

<sup>A</sup> Alliance to Feed the Earth in Disasters (ALLFED), Fairbanks, AK, USA.

<sup>B</sup> University of Alaska Fairbanks, Fairbanks, AK, USA 99775.

<sup>C</sup> Department of Civil, Architectural and Environmental Engineering, University of Naples Federico II, Via Claudio 21, 80125, Napoli, Italy.

<sup>D</sup> Department of Materials Science & Engineering and Department of Electrical & Computer Engineering, Michigan Technological University, Houghton, MI, USA.

### Abstract

Human civilization's food production system is currently unprepared for catastrophes that would reduce global food production by 10% or more, such as nuclear winter, supervolcanic eruptions or asteroid impacts. Alternative foods that do not require much or any sunlight have been proposed as a more cost-effective solution than increasing food stockpiles, given the long duration of many global catastrophic risks (GCRs) that could hamper conventional agriculture for 5 to 10 years.

Microbial food from single cell protein (SCP) produced via hydrogen from both gasification and electrolysis is analyzed in this study as alternative food for the most severe food shock scenario: a sun-blocking catastrophe. Capital costs, resource requirements and ramp up rates are quantified to determine its viability. Potential bottlenecks to fast deployment of the technology are reviewed.

The ramp up speed of food production for 24/7 construction of the facilities over 6 years is estimated to be lower than other alternatives (3-10% of the global protein requirements could be fulfilled at end of first year), but the nutritional quality of the microbial protein is higher than for most other alternative foods for catastrophes. Results suggest that investment in SCP ramp up should be limited to the production capacity that is needed to fulfill only the minimum recommended protein requirements of humanity during the catastrophe. Further research is needed into more uncertain concerns such as transferability of labor and equipment production. This could help reduce the negative impact of potential food-related GCRs.

## **Keywords**

Global Catastrophic Risk, Existential Risk, Single Cell Protein, Hydrogen-oxidizing bacteria, Food Security, Nuclear Winter.

## **Abbreviations**

SCP (Single Cell Protein)

GCR (Global Catastrophic Risk)

CapEx (Capital Expenditure)

OpEx (Operating Expenditure)

SMR (Steam Methane Reforming)

WGS (Water-Gas Shift)

HOB (Hydrogen Oxidizing Bacteria)

DAC (Direct Air Capture)

## **Funding**

This research was supported in part by the Alaska Space Grant Program at University of Alaska (from NASA) and the Alliance to Feed the Earth in Disasters (ALLFED). Dr. Silvio Matassa is funded as a postdoctoral researcher by the Biofeedstock project, financed under the National Operation Program (PON Italy) 2014-2020. Dr. Joshua Pearce is funded by the Witte Endowment. NASA was involved in study design, but ALLFED was the only funding body to influence the other parts of this research.

# 1 Introduction

Current future food security research concentrates on addressing incremental factors such as population increase, resource scarcity, resource depletion and climate change (Henchion et al., 2017). Some estimates, however, predict around 80% chance of a food shock that reduces global food production by about 10% and about 10% chance of total food production loss, both within this century (Bailey et al., 2015; Denkenberger and Pearce, 2014; Denkenberger et al., 2017). Scenarios that present an approximate 10% food production loss such as severe pollinator loss or abrupt climate change could produce mass starvation, because even disasters that do not affect the food system directly (like the COVID-19 pandemic) can considerably increase the share of population at risk of starvation (Beasley, 2020). Climate change is rarely considered in its abrupt/extreme forms with regard to food security in contrast to the commonly discussed “incremental” climate change. The less likely but more abrupt variant could produce significant changes within the scale of a decade instead of a century, leaving much less time for adaptation. Its potential to create severe food shocks is thus higher (Denkenberger and Pearce, 2015) and should not be discounted.

Sun-blocking global catastrophes are the most extreme food shocks that could potentially affect humanity in the near future, because they entail almost complete food production loss for humanity by making conventional agriculture unfeasible globally for many years (Denkenberger et al., 2017). They are selected as a limiting case scenario to assess the feasibility of potential solutions to food shocks because a solution that works in such extreme circumstances could potentially be useful in shocks of any scale. This type of catastrophe could cause below freezing temperatures over much of the Northern Hemisphere during summer (Coupe et al., 2019). There are a number of catastrophes that could obscure the sun, including full-scale nuclear war causing a nuclear winter from soot rising from the burning of cities. Other less likely ones include a supervolcanic eruption or an asteroid or comet impact (Cirkovic, 2008; Denkenberger and Pearce, 2014). These are categorized as global catastrophic risks (GCRs), defined as events that could damage human well-being on a global scale, even endangering or destroying modern civilization (Bostrom and Cirkovic, 2011). In this work we explore a sun-blocking GCR scenario in which global industry has not been significantly disrupted by the catastrophic event.

The collapse of traditional agriculture during the aftermath of these events would require new sources of nourishment for the world population. Feeding everyone in this scenario is a significant challenge that would probably require a mix of different, complementary solutions. To the best of our knowledge, neither the United Nations nor any particular government has a publicly available response plan to a sun-blocking scenario as described here. Alternative foods that do not require much or any sunlight have been proposed in academia as a more cost-effective solution (Denkenberger and Pearce, 2018, 2016) than increasing food stockpiles, given the astronomical cost of storing enough food to feed humanity through a 5 to 10-year nuclear winter (Baum et al., 2016, 2015).

For instance, trees can be used to cultivate mushrooms and electricity, biomass, coal or natural gas can fuel nutritious bacteria growth (Denkenberger and Pearce, 2014, 2015). In the event of a severe food shock, substitute diets could be the only alternative capable of avoiding starvation and sustaining human society. Additionally, components of alternative food production may apply outside of an instance of global disaster including growing mushrooms on residue from logging, producing sugar from leaves (Throup et al., 2021) or ramping up global seaweed production, among

the most promising ones. There is great potential for alternative foods and humanity should explore them as part of its food crisis response preparation (Denkenberger et al., 2017), as has been done with microbial protein from hydrogen in this work, and potentially for use under normal circumstances of food supply. Indeed, microbial protein first gained traction during wartime due to protein scarcity (Ritala et al., 2017). Currently there are few organizations working on alternative food solutions to catastrophic scenarios, such as the Alliance to Feed the Earth in Disasters (ALLFED, 2017) and Pennsylvania State University in collaboration with Open Philanthropy (LaJeunesse, 2020).

Through this lens, protein producing microorganisms could be considered as much more than a tool for valorization and sustainability as usually discussed (Claassens et al., 2016), they could also be instrumental in saving substantial numbers of human lives and civilization itself from disaster. Microbial protein has been previously studied as alternative food for catastrophes in an exploratory manner and concerns about material constraints were raised (Denkenberger and Pearce, 2014), which are addressed in this work.

### **1.1 Background on Single Cell Protein (SCP)**

Microbial protein is generally referred to as single cell protein (SCP) and has been proposed as one of the possible alternatives to fulfill the growing global protein demand (Ritala et al., 2017). Multiple feedstocks can be used for SCP production, ranging from human edible products such as sugar to waste products including resources recovered from wastewater (Matassa et al., 2015a). The feedstock used generally depends on whether the resultant food product is intended for animal or human consumption. Additionally, a variety of microorganisms can be cultivated for SCP production, including microalgae, bacteria and fungi (Ritala et al., 2017). Fungal SCP is currently sold in some stores under the brand name Quorn, but it would be less useful in a catastrophe because the current production process uses a feedstock that is human edible (Ritala et al., 2017). This work is focused on hydrogen oxidizing bacteria (HOB) which, in presence of oxygen, can use hydrogen as an electron donor and convert CO<sub>2</sub> into microbial biomass with a high protein content.

Much has been said about how SCPs can be a sustainable source of food. Hydrogen-based SCP (H<sub>2</sub> SCP) produced via solar powered electrolysis accounts for significantly lower greenhouse gas emissions than traditional protein sources such as meat and plant based protein (Vainikka, 2018), in addition to a much lower water footprint and land use (Sillman et al., 2019). Furthermore, since it does not compete with traditional protein sources in terms of feedstocks, H<sub>2</sub> SCP can complement them.

More importantly for our purposes, H<sub>2</sub> SCP has the potential to produce high quality protein rich food independently of the traditional agricultural system and sunlight itself when depending on electricity or fuel. It does not require the use of human edible feedstocks, which would most likely be better used directly as human food during an agricultural collapse scenario. In addition, its energy efficiency is very high compared to most other sunlight-independent food sources such as artificial light grown crops (Denkenberger and Pearce, 2014).

H<sub>2</sub> SCP could potentially be used as an ingredient in foods such as bread, pasta, plant-based meat and dairy, and as a protein supplement similar to whey protein shakes (Southey, 2019), which means that it could be consumed in different forms such as meat-like products and drinks or

broths. It has very high protein completeness since its essential amino acid content is similar to or higher than the FAO guidelines (Ritala et al., 2017), better than that of soybean meal and with a generally higher protein content (Pikaar et al., 2018). To the best of our knowledge, no studies of SCP protein bioavailability in humans are available, but studies in fish point to high digestibility of bacterial protein (Glencross et al., 2020). Based on similarity with methane based bacterial SCP the caloric content can be expected to be higher than that of carbohydrates in general thanks to its fat content with 22 MJ/kg for methane SCP (Unibio Group, 2020) versus 17 MJ/kg for carbohydrate (U.S. Department of Agriculture, 2016). However, this variety of SCP has high nucleic acid content (8-12%) (Volova and Barashkov, 2010), which could cause problems such as gout and kidney stones (Ritala et al., 2017) in case of abundant use in animals with a long lifespan. A significant amount of SCP consumption is not recommended for humans unless the nucleic acid content is reduced during SCP processing prior to their use. The maximum safe limit for a person is 4 g/day (Adjei et al., 1995), which is equivalent to the content found in 234 kcal worth of unprocessed bacterial SCP, or at most 59% of the daily protein requirement of 60 g protein/day.

Fungal SCP has been considered a safe dietary component for years (U.S. Food and Drug Administration, 2002). It has a particularly low nucleic acid content compared to other SCPs and is sold after post-processing to even further reduce the content (Ritala et al., 2017) below 2% dry weight (Marlow Foods Ltd., 2001). This represents a safe share since, even when fulfilling all protein requirements using only SCP, the total nucleic acid intake would be below the safe limit. Fungal SCP has been proven to pose little to no threat regarding human consumption, with a low incidence of allergic reactions compared to many other protein sources (Finnigan et al., 2019). In comparison, bacterial SCP is considerably less studied as a human food source, but the fungal SCP example sets a favorable precedent. Regardless, studies on safety in human consumption are still needed for bacterial SCP.

The main companies currently pioneering mass production of H<sub>2</sub> SCP are: SolarFoods, NovoNutrients, Avecom, Deep Branch Biotechnology, Kiverdi and LanzaTech. Some, including SolarFoods, are developing the technology to produce human food-grade SCP. With companies actively pushing for commercialization of bacterial SCP for human consumption, it is likely that the necessary safety studies will be carried out in subsequent years. Using H<sub>2</sub> SCP as animal feed was not considered an option, since the caloric conversion efficiency of animal products typically ranges between 3%-17% (Shepon et al., 2016), significantly reducing the amount of calories available during the shortage scenario. Instead, the calculations are done for SCP as a direct human food source.

In order to assess the feasibility of H<sub>2</sub> SCP as an alternative food in a catastrophe, this study first reviews the background on microbial protein to outline the technical processes necessary for scaling up production to provide food during a global catastrophe. Next, the capital costs of this scale up are estimated, the resources required are quantified, and the ramp up rates are calculated in order to determine the economic viability of this alternative food. The results are presented and discussed in the context of providing techno-economic insurance for GCRs.

## 2 Methods

There are four main inputs for the proposed H<sub>2</sub> SCP production: 1) a carbon source, 2) a hydrogen source, 3) a nitrogen source and 4) an oxygen source. Additionally, some minerals are also needed in smaller quantities. HOB that do not require oxygen may also be used (McWard, 2017), but have not been considered in this work.

Multiple industrial options are available to produce H<sub>2</sub>, including, but not limited to: i) steam methane reforming (SMR), ii) electrolysis of water and iii) gasification of solids (e.g. coal or biomass). Despite being the current industry standard process, SMR is not considered as an option because of the existence of microbes known as methane-oxidizing bacteria that can produce SCP directly from methane without the need to convert it to hydrogen or supply an external carbon source, which will be the subject of future work. The capability to use methane without reforming would imply lower capital and material requirements, suggesting that direct use of methane, where available, would most likely be preferable. Obtaining hydrogen from waste or byproducts of the chemical and related industries is considered beyond the scope of this work due to high complexity and limited availability and accessibility; however, it is technically feasible (Matassa et al., 2020) and worth considering in future research.

Electrolysis and gasification are the remaining promising options for the process of generating hydrogen. Water electrolysis requires electricity, which in this analysis is considered to be coming from the electrical grid. In-situ production of electricity is technically feasible, but beyond the scope of this analysis. Renewable energy sources such as solar photovoltaic (PV) electricity, are often discussed in literature for the sustainable production of hydrogen for SCP (De Vrieze et al., 2020; Matassa et al., 2015a; Pikaar et al., 2018; Sefton, 2018; Sillman et al., 2019; Vainikka, 2018), but would not be viable in a sun-blocking catastrophe scenario. PV would, however, be useful for SCP production for GCRs that cut off agricultural output while the sun remained unblocked (e.g. crop diseases). For gasification based H<sub>2</sub> SCP production, different alternatives are available as a feedstock, among which coal was selected as representative due to widespread availability. It is expected that during a catastrophic food shock the need to avoid mass starvation would overcome the environmental concerns of the use of coal, especially since a significant part of the CO<sub>2</sub> produced via gasification would be used as a carbon source for the SCP.

Electrolysis based H<sub>2</sub> SCP production requires an external carbon source. This study conservatively uses direct air capture (DAC) of CO<sub>2</sub> as the basis of our calculations; however, CO<sub>2</sub> capture from industrial emitters is in most cases less expensive and in some cases can already contain some amount of hydrogen that can be used. These sources are plentiful and can sometimes be used with modest investment in purification technology, since the production process is quite flexible in terms of contaminants (Sefton, 2018). For the gasification case, the CO<sub>2</sub> produced from coal suffices (Gnanapragasam et al., 2010).

The nitrogen requirements can be satisfied by using ammonia from the fertilizer industry, since in a sun-blocking scenario many fertilizer plants would likely be idle due to the much lower agricultural production. The oxygen is obtained together with the hydrogen in the electrolysis process or separated from air in the gasification based process.

The chemical reaction used as a reference is the one proposed for *Cupriavidus necator* derived from estimates of cultures by (Ishizaki and Tanaka, 1990) as shown in equation 1.



The unit operations, mass and energy flows involved in the two proposed upstream reference processes are shown in Figures 1 and 2 for the electrolysis-based and gasification-based H<sub>2</sub> SCP production processes, respectively. Then the downstream process of the H<sub>2</sub> SCP production is shown in Figure 3. The first step is obtaining H<sub>2</sub>, O<sub>2</sub> and CO<sub>2</sub> as the main inputs for the HOB. In the electrolysis based process, H<sub>2</sub> and O<sub>2</sub> are obtained directly from water, while CO<sub>2</sub> is obtained from the chosen source, in this case from ambient air via DAC. In the gasification based process, O<sub>2</sub> is obtained in an air separation unit (ASU), whereas the H<sub>2</sub> and CO<sub>2</sub> are obtained from coal in the gasification section. In both cases H<sub>2</sub>, O<sub>2</sub> and CO<sub>2</sub> are fed together with ammonia and minerals to the bioreactor where the cell growth takes place in a continuous fermentation system.

The liquid effluent from the bioreactor is represented by the fermentation broth, usually characterized by 1-3% dry weight biomass (i.e. bacterial cells) and some unutilized nutrients. The effluent is sent to the downstream processing section where the water will be removed through mechanical dewatering and drying steps. Finally, the SCP product will be processed into an easily storable powdered form via spray drying. The nucleic acid content of the product can be reduced by means of processes such as a heat treatment applied to the effluent fermentation broth, alkaline treatment or chemical extraction (Ritala et al., 2017). It is yet unknown which specific nucleic acid removal treatments will be used at large scale production of bacterial SCP, but heat treatment is shown in Figure 3 as an example as used in fungal SCP production. This operation is based on the activation of endogenous RNA degrading enzymes at controlled temperature and pH conditions for a short time (Ritala et al., 2017). Degraded nucleic acids then diffuse out of the cell membrane into the liquid fraction, which is separated from the SCP biomass during mechanical dewatering (e.g. centrifugation). It may be possible to leverage RNA degrading enzymes at ambient conditions over longer times, but this has not been considered in this work.

Another option for electrolysis based SCP production would be in situ electrolysis, which combines electrolysis and fermentation in a single unit. This could potentially lower the energy requirements of the process (Sillman et al., 2019), but it has been conservatively ignored due to the low cell titer and volumetric productivity values achieved so far by such systems (Sillman et al., 2019).

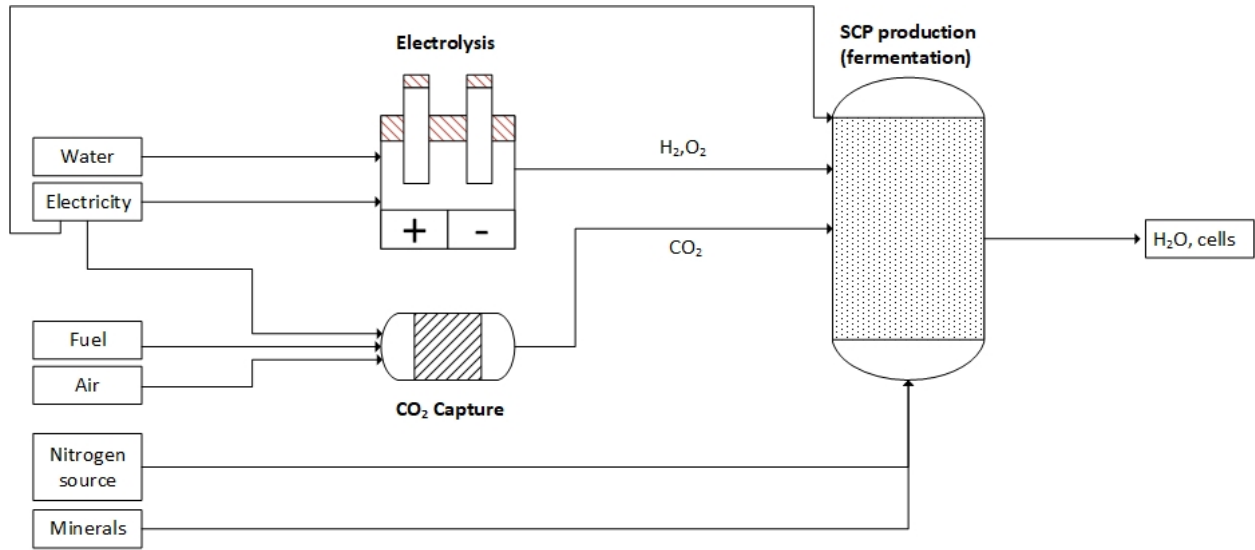

Figure 1. Upstream section of the electrolysis based H<sub>2</sub> SCP production process.

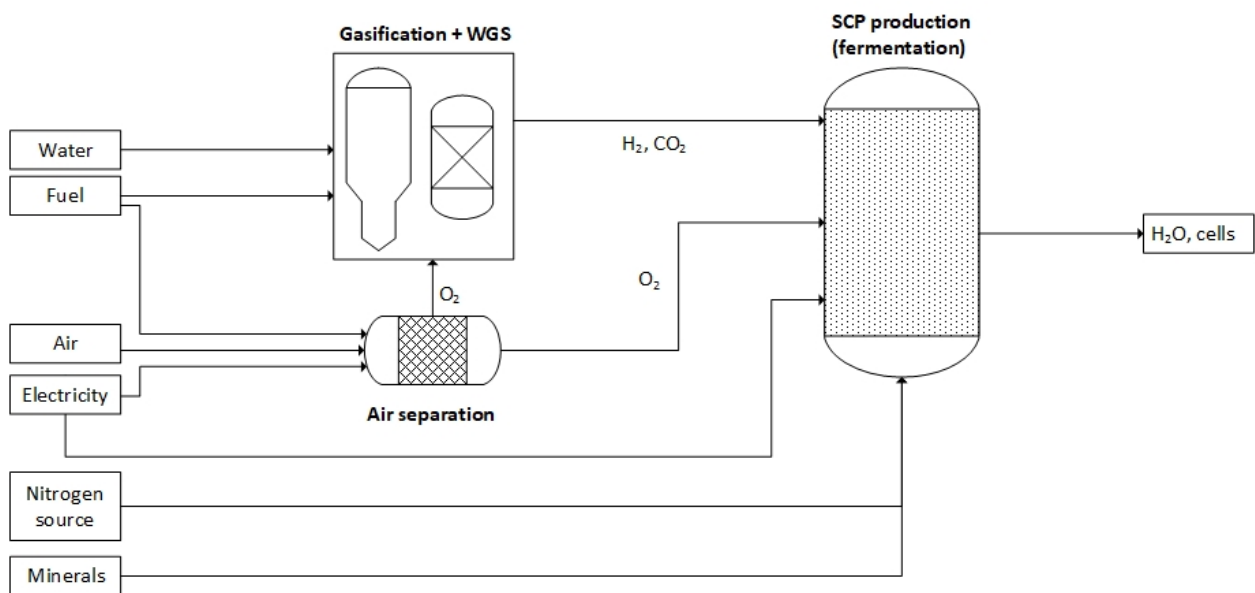

Figure 2. Upstream section of the gasification based H<sub>2</sub> SCP production process.



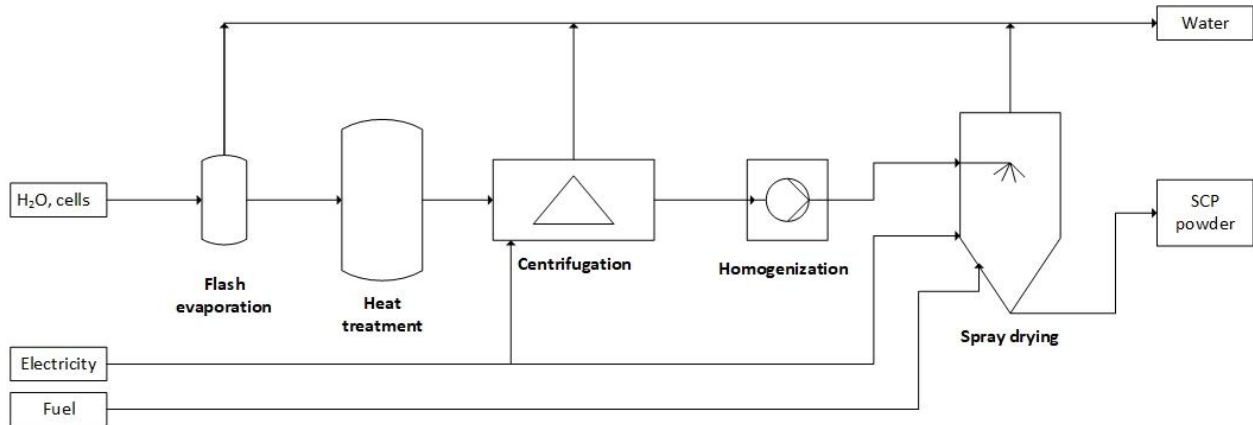

Figure 3. Downstream section of the H<sub>2</sub> SCP production process.

## 2.1 CapEx estimation

This work accounts for uncertainty by providing a ranged estimate of fixed and variable costs. The range of values of the fixed capital expenditure (CapEx) of the SCP plants was based on data from published industrial estimations by Unibio A/S and NovoNutrients together with cost estimates from H<sub>2</sub> production facilities from the literature.

Based on Unibio's published data (Jorgensen, 2011), from the yearly revenue and product price the reference plant produces approximately 108,000 tonnes of dry product per year. The same processes and equipment used to produce methane SCP can be used to produce hydrogen SCP; thus the CapEx of this plant can be used as a basis of calculation for a H<sub>2</sub> SCP plant, except for the H<sub>2</sub> production unit. As the growth rate of methane-oxidizing bacteria is slower than that of HOB (Matassa et al., 2015b), this is a conservative assumption. All calculations are for this reference production capacity as this variable affects the CapEx value due to economies of scale. As of the time of writing, Unibio A/S and Calysta are both building methane SCP production plants with a capacity of around 100,000 tonnes per year (Calysta Inc., 2020; Lane, 2018), and NovoNutrients has expressed interest in developing a H<sub>2</sub> SCP plant of similar capacity (Rosenberry, 2019; Sefton, 2018). Thus, the reference capacity of 108,000 tonnes per year is used as a representative of the plant scale that could be used in the proposed scenario, which after nucleic acid removal becomes 100,800 tonne SCP/year.

The values of NovoNutrients' published estimates for a H<sub>2</sub> SCP large scale plant (Sefton, 2018) are used as a reference for the inputs and outputs of the proposed reference plant, namely the hydrogen and CO<sub>2</sub> requirements for a given SCP production capacity (which incorporate gas utilization and other process inefficiencies). 108 tonne/day of H<sub>2</sub> and 600 tonne/day of CO<sub>2</sub> are required to produce 274 tonne/day of SCP. This is slightly lower than the Unibio reference plant (297 tonne/day), but since the scale is similar the values can be scaled linearly in subsequent calculations.

The scaling methodology applied to both the gasification-based and electrolysis-based H<sub>2</sub> production options was similar. First a reference plant was selected, which is representative of the

type of process that could be used to produce H<sub>2</sub>. Then the power-sizing scaling technique as shown in equation 2 is applied to obtain the cost of a unit of the required size for the reference plant (Blank and Tarquin, 2008), where C<sub>1</sub> is the unit cost at capacity Q<sub>1</sub>, C<sub>2</sub> is the unit cost at capacity Q<sub>2</sub> and x is the cost capacity exponential scaling factor.

$$C_2 = C_1(Q_2/Q_1)^x \tag{2}$$

The capital cost of the gasification unit comes from a summary study of several coal gasification technologies, specifically Texaco gasifiers combined with water-gas shift (WGS) reactors performed by Kreutz et al. (Bartels, 2008). The capital cost of the electrolyzer unit is derived from Shell’s Rheinland refinery unit (Rivett, 2019). The capital cost of the ASU can be directly estimated based on the values proposed by (Kreutz et al., 2005). The capital cost of DAC is estimated using (Keith et al., 2018) n-th plant estimate as a reference. All costs are updated to 2020 values using the Chemical Engineering Plant Cost Index (CEPCI).

To account for uncertainty in the calculation, a range of values for the CapEx was obtained for the gasification and electrolysis units. First, a high and a low cost-capacity scaling factor (x) are applied to both options. The factors for electrolysis are 0.55 and 0.75, from a review of proton exchange membrane (PEM) electrolyzers and regenerative fuel cells (Mittelsteadt et al., 2015). For the gasification unit, the high scaling factor was selected as 0.82 based on that of integrated gasification plants (Baumann, 2014) while the low factor was considered as 0.6 as a typical assumption for the chemical industry (Black, 1984). Secondly, a high and a low CapEx value are selected for the gasification reference unit, namely 1.138 billion USD (gasification with quench cooling) and 1.391 billion USD (gasification with syngas cooling) (Bartels, 2008), both with no CO<sub>2</sub> capture since we are assuming direct use of the syngas outlet of the water-gas shift (WGS) unit.

The capital cost of building a reference size H<sub>2</sub> SCP plant is calculated by adding the updated capital costs of the reference SCP production plant and the H<sub>2</sub> production section. Then, because the aim is to produce food as early as possible, the time it would take to build the new plants is estimated by using fast construction methods, which are sometimes used in industry. Constructing around the clock, 24/7 reduces overall construction time to 32% of the original at an increased capital cost of 46% (Throup et al., 2021). Given the severity of the scenario, experience in the COVID-19 pandemic suggests a delay of 4 weeks before construction begins (Betti and Heinzmann, 2020), which was the time it took for complex industries to convert and scale production during the pandemic. Investment in planning now could reduce that delay.

## 2.2 Assessment of required resources

The electricity and fuel energy requirements to operate a reference size plant are calculated based on published estimates for H<sub>2</sub> SCP, microbial protein in general, and chemical industrial equipment. These are summarized in Table 1.

Variable	Value	Unit	Source
CO <sub>2</sub> requirement	0.43	kg CO <sub>2</sub> /kg SCP	(Sefton, 2018)

H <sub>2</sub> requirement	2.41	kg H <sub>2</sub> /kg SCP	(Sefton, 2018)
Energy content of SCP	22	MJ/kg	(Unibio Group, 2020)*
Expected electrolyzer efficiency	70%		(Shiva Kumar and Himabindu, 2019)
Minimum energy required to produce hydrogen	39.4	kWh/kg H <sub>2</sub>	(Züttel et al., 2011)
Gasification mass yield	0.202	kg H <sub>2</sub> /kg coal	(Gnanapragasam et al., 2010)
Coal heating value	32.9	MJ/kg	(Gnanapragasam et al., 2010)
Solid content of dryer inlet	20%		(Sillman et al., 2019)
Energy consumption of spray dryer	4,880	kJ/kg evaporated water	(Baker and McKenzie, 2005)
Electricity to thermal energy usage ratio of spray dryer	1:27	Electricity:thermal	(Baker and McKenzie, 2005)
DAC energy requirement	8.81	GJ/tonne CO <sub>2</sub> captured	(Keith et al., 2018)
Electricity to thermal energy usage ratio of DAC	17%	Electricity/thermal	(Sillman et al., 2019)
Energy use of fermentation step	1.6	kWh/kg SCP	(Pikaar et al., 2018)
Energy use of air separation	0.357	kWh/kg O <sub>2</sub>	(Aneke and Wang, 2015)

Table 1. Basis of calculation for the energy requirements of H<sub>2</sub> SCP production. \*To the best of our knowledge there is no source which states the exact calorie content of SCP produced from hydrogen, so we are taking it to be similar in this regard to SCP from methane, with a value of 22 MJ/kg based on the UniProtein methane SCP product.

To assess the feasibility of scaling up H<sub>2</sub> SCP and identify possible bottlenecks to the ramp up, the amounts of SCP required for fulfilling the recommended protein requirements of the current global population and for fulfilling the total caloric requirements are calculated. This was done by comparing the amount of protein and calories contained in the SCP product and the requirements for feeding one person to the amount of people in the world, allowing to obtain the mass of SCP needed and the number of reference plants required to produce it. The values used as a basis for the analysis are summarized in Table 2. A similar calculation was performed for the required minerals based on the expected mineral content of the SCP product (Unibio Group, 2020) and the current production of the minerals in their bioavailable forms, in addition to special materials

required for the production of the equipment such as noble metals for the electrolyzers and catalysts for the WGS units.

Variable	Value	Unit	Source
World population	7.8	Billion people	(United Nations, 2019; Worldometers, 2020)
Recommended protein intake	60	g/person/day	(World Health Organization and United Nations University, 2007)
Expected food waste	12%	% of calories produced	*
Electricity consumption	2,551	GW	(Sönnichsen, 2020)
Installed electricity capacity	5,150	GW	(Sönnichsen, 2019)
Global coal production	7,337	Megatonne/year	(Rob Smith, 2018)
Global ammonia production	171	Megatonne/year	(Research and Markets Ltd, 2020)
Average daily caloric requirement per person	2100	kcal/person/day	(World Health Organization, 2004)
Ammonia requirement	0.0356	mol NH <sub>3</sub> /mol H <sub>2</sub>	(Ishizaki and Tanaka, 1990)
	0.1432	kg ammonia/kg SCP	

Table 2. Basis of calculation for the resource availability analysis. \*No matter how dire the food crisis is, the presence of some amount of food waste throughout the system is unavoidable. In the proposed scenario food waste is expected to be lower than the current value due to decreased food availability. Additionally, The dry SCP has a long expiration date, so a reasonably low value of 12% food waste was considered (Denkenberger and Pearce, 2014).

The protein content of the final SCP product is a key variable to estimate the amount of it required to fulfill global protein requirements. A review of multiple sources suggested that the protein content per kg of dry SCP product would be in the range of 50-80% (Ravindra, 2000). This range was considered directly in the calculation of the approximate amount of each of the required resources needed to produce the amount of SCP required, namely electricity and coal, ammonia (as a proxy of available nitrogen) and minerals required for bacterial metabolism. Based on similarity

with Uniprotein (methane SCP), a nucleic acid mass content of 9% was considered (Unibio Group, 2020) which is reduced to 2% in downstream processing.

### **2.3 Ramp up speed**

In order to estimate the amount of food that could be produced, and how quickly this could be scaled up to feed everyone in the world, the budget that might be available is needed to scale the production facilities with capital costs calculated as described above. Given the recent 2 trillion USD stimulus package against COVID-19 in the U.S. and the further 3 trillion that passed the House of Representatives there (Lowey, 2020; McConnell, 2020), one could argue that in global disasters there may not be financial limitations. Construction, however, will still be limited by physical resources, such as materials and trained labour. The global CapEx for similar industries that would not require much retraining or materials substitution, such as chemicals, power, paper and breweries are included to give a budget of 489 billion USD per year (Damodaran, 2020). It is likely that other industries could also retrain to aid in construction, but this was conservatively excluded.

This value was used to determine how many facilities could be scaled up concurrently. The budget was divided by the total capital to find the number of facilities that could be constructed per year. The time taken to construct a facility has been shown to be logarithmically related to the cost of the facility itself, and a regression model based on this principle was used to determine the time of construction (Martin et al., 2006). The number of 'waves' of facilities that would complete construction each year was calculated using the construction time. The number of facilities that could be built at the same time was therefore calculated from the total budget each year divided by the number of waves. This is combined with the known production capacity for each facility and the amount of food required to feed the global population to show the ramping rate of production across the world and the proportion of the world's food requirements that could be satisfied. A startup period with a duration equivalent to a fourth of the regular speed construction time was assumed, during which an average production capacity of 50% applies (Humbird et al., 2011). More details can be found in (Throup et al., 2021) and the example in the supplementary material.

### **2.4 Economic analysis**

A net present value (NPV) analysis was performed to estimate the break-even cost of the SCP product. The value was obtained by calculating the revenue needed per unit of SCP produced when NPV equals zero. To represent the duration of a strong food shock, 6 years of operation are used instead of the usually longer timelines for chemical plants. This is the expected duration for a period with little sunlight caused by a supervolcanic eruption or nuclear winter. The cost was also estimated for a typical 20 year long project timeline for comparison. At the end of the 6 year period the equipment was considered to be depreciated, which is an extremely conservative assumption. The discount rate used to account for the time value of money was 10%, as recommended when in absence of statistical data for the technology (Short et al., 1995).

The variable costs are estimated based on the electricity and coal requirements for a reference plant from Table 6 and the prices from Table 3. A typical cost for the aluminum industry was used for the low end of the uncertainty range, whereas the current European industry average was used for the higher one. The US industry average is shown for comparison. The costs of thermal energy

are calculated based on the cost of coal that would be required to satisfy them. The total variable costs included these together with an additional 10.6 million USD to account for other variable costs and 6.5 million USD of overheads (Jorgensen, 2011). A working capital of 32.6 million USD was presumed. The revenue was considered to be taxed by a 35% rate (Humbird et al., 2011). Financing consisted of 70% equity (10% return on investment), and the remainder a loan with an interest of 8% and a 10 year payment term. It should be noted that this is a common assumption but the financial conditions of a global catastrophe are complex and outside of the scope of this work. It could be the case that governments would give interest free loans as happened during the COVID-19 pandemic, or conversely that raising capital becomes more difficult in the financial ecosystem, so uncertainty is high.

Price range	Low	Middle	High
Electricity price (\$/kWh)	Global low (Burns, 2015)	US average (EIA, 2020a)	Europe average (Eurostat, 2019)
	0.03	0.07	0.13
Coal price (\$/tonne)	Global low (EIA, 2020b)	10-year Average (Markets Insider, 2020)	10-year high (Markets Insider, 2020)
	11.60	45.80	80.00

Table 3. Electricity and coal cost ranges considered.

### 3 Results

#### 3.1 Capital cost

The capital cost of the hydrogen production section is shown in Tables 4 and 5 together with the values used to estimate it as described in section 2.1. Note that the required electrolyzer system for a reference size plant is of a scale much larger than the current largest in the entire world (Rivett, 2019).

Reference capacity	148	kg H <sub>2</sub> /h
Reference cost (2019)	17.8	million USD
Scaling factor	0.55	0.75
Required capacity	4,879	kg H <sub>2</sub> /h

Required cost	121	244	million USD
---------------	-----	-----	-------------

Table 4. Electrolysis H<sub>2</sub> production unit expected cost range.

Reference capacity	32,113		kg H <sub>2</sub> /h
Reference cost (2019)	1,316	1,608	million USD
Scaling factor	0.82	0.6	
Required capacity	4,879		kg H <sub>2</sub> /h
Required cost	281	519	million USD

Table 5. Coal gasification H<sub>2</sub> production unit expected cost range.

The updated capital cost of the air separation unit required to produce the oxygen input for a gasification based plant is estimated at 49 million USD based on (Kreutz et al., 2005). The range of capital cost of DAC has been estimated between zero (assuming free CO<sub>2</sub> from an industrial source) and 317 million USD based on equation 2 and (Keith et al., 2018) n-th plant estimate with a cost-capacity factor of 0.6. The 2019 updated capital costs of the gasification section and ASU are added to the cost of the Unibio reference to obtain the capital cost of the gasification based process, while for the electrolysis based process the costs of the electrolyzer and DAC are added to the Unibio reference.

The results are a capital cost of between 386-858 million USD for the electrolysis based H<sub>2</sub> SCP plant of the reference capacity and 602-850 million USD for the gasification based option. These translate to an investment per unit of installed capacity of approximately \$3,800-8,500/tpa and \$6,000-8,400/tpa (USD over tonnes per annum), respectively. This is in comparison to NovoNutrients' proposed value of \$3,400/tpa for a plant of similar scale (Sefton, 2018). The overall higher values are likely a product of the conservativeness of the estimations, which is necessary to account for uncertainty, and this analysis is aiming at reflecting the cost of human food instead of animal feed. After updating to fast construction cost, the CapEx values lie at 563-1,229 million USD for electrolysis and 879-1,240 million USD for gasification for a H<sub>2</sub> SCP plant of the reference capacity of 100,800 tonne/year. In terms of capital invested per unit of installed capacity this is equivalent to \$5,600-12,400/tpa and \$8,700-12,300/tpa, respectively. Based on these values, we estimated how fast the ramp up or deployment of the technology would be in the proposed catastrophe scenario.

### 3.2 Required resources and operating cost

The energy requirements estimated for each step are shown in Table 6. The electrolysis based process includes all the steps if DAC is used, whereas the gasification process includes only fermentation, centrifugation and drying apart from H<sub>2</sub> production via gasification. All values are calculated from Table 1: Electrolysis requirements are obtained from the hydrogen requirements per kg of SCP produced, the specific energy of hydrogen and the proposed electrolyzer efficiency of

70%. Gasification requirements are based on the hydrogen yield of a gasifier and WGS system from literature, the hydrogen requirements and the energy content of coal. The fermentation and centrifugation energy requirements are taken from a resource analysis study. CO<sub>2</sub> DAC energy use was estimated based on an absorbent system from literature and the CO<sub>2</sub> requirements. Spray drying requirements are obtained from the industry average of a study on industrial spray drying data and the expected solid content of the inlet stream. All values are corrected for nucleic acid removal.

Step	Energy cost (kWh/kg SCP)
Electrolysis	23.9
Fermentation	1.6
CO <sub>2</sub> Direct air capture	5.8
Centrifugation	0.8
Spray drying	5.8
Total energy requirements for H <sub>2</sub> SCP production via electrolysis and DAC	37.8
Air separation	0.8
Coal gasification*	19.2
Total energy requirements for H <sub>2</sub> SCP production via gasification	27.4

Table 6. Energy requirements of H<sub>2</sub> SCP production per step in kWh over dry mass of product. \*Coal gasification energy cost refers to the energy equivalent of coal consumed for H<sub>2</sub> production.

The energy analysis results for a reference plant are shown in Table 7. The values are estimated based on Table 6 and the energy content of SCP and thermal to electrical energy ratios from Table 1. For the sake of simplicity, the thermal energy required in the spray drying and DAC steps is shown based on its energetic equivalent to coal, since that was how its cost was estimated. The energy efficiency represents the amount of energy invested in producing the SCP in comparison with its caloric content. The overall energy efficiency of the electrolysis option is 16.5%, but if the CO<sub>2</sub> could be obtained directly from an external source the value would be 19.4%. For coal gasification it is 22.1%. These results are consistent with SolarFoods' estimation of around 20% efficiency for the electrolysis option (SolarFoods, 2019).

	Variable	Value	Unit
Electrolysis and DAC	Total energy requirements of reference plant	435	MW
	Of which electricity is	315	MW
	Overall energy efficiency	16.5%	
Gasification	Coal requirement of gasifier	212,014	tonne/year
	Total energy requirements of reference plant	324	MW
	Of which electricity is	39	MW



	Overall energy efficiency	22.1%	
Coal equivalent of thermal energy required for reference plant	Spray dryer	62,039	tonne/year
	DAC	53,140	tonne/year

Table 7. Energy analysis results for a reference plant.

The share of global resources that would be required to fulfill the protein requirements of the global population via H<sub>2</sub> SCP is shown in Table 8 for both ends of the expected protein content range. No resource bottlenecks are identified in comparison to the current availability.

		Low end	High end	
	Protein content of H <sub>2</sub> SCP	80%	50%	
	H <sub>2</sub> SCP requirement	243	388	Megatonne/year
Electrolysis based option	Electricity capacity required	0.76	1.21	TW
	Share of global electricity consumption	30%	48%	
	Share of global electricity capacity	15%	24%	
Gasification based option	Coal required	511	817	Megatonne/year
	Share of global coal production	7%	11%	
Nitrogen source	Ammonia required		43	Megatonne/year
	Share of global ammonia production		25%	

Table 8. Range of the share of global electricity consumption, coal production and ammonia production required to fulfill the minimum global human protein requirements, while accounting for 12% food waste. \*The share of global coal production required by gasification only includes the coal consumed in the gasification step. The thermal energy requirements of both options and the electricity requirements of the gasification based process are not included here as these could be provided by other technologies.

The share of global electricity consumption required to fulfill the caloric requirements of the global population is 215% (107% if the electrical system were at 100% duty cycle) while the share of global coal production required would be 37%. The associated ammonia requirement for either method would equate to 106% of total global production. The electricity value is in agreement with SolarFoods' estimation of feeding everyone in Finland using one fifth of their electricity consumption (SolarFoods, 2019) which proportionally would amount to 184% of the current global energy consumption for feeding the global population.

SCP production requires minerals for bacterial cell growth metabolism, including phosphorus, sulfur, sodium, chlorine, calcium, iron, magnesium and potassium among others. We estimated the

global production of bioavailable forms of these minerals as shown in Table 9 and identified magnesium as a potential bottleneck to SCP production ramp-up. Note that these values are roughly estimated based on the content present in the SCP product (Unibio Group, 2020) and not on the minimum requirements to produce it; actual mineral requirements may be lower.

Micronutrient form	Global production	Amount required	Share of global production	Source
	tonne/year	tonne/year		
Phosphate	240,000,000	40,300,000	17%	("Phosphate rock mining by country," 2019)
Sulfur	78,900,000	6,900,000	9%	("Sulfur production globally by country," 2019)
Sodium Chloride	293,000,000	15,800,000	5%	(Salt Data Sheet - Mineral Commodity Summaries, 2020)
Calcium carbonate	167,800,000	14,800,000	9%	(Grand View Research, 2019)*
Potassium chloride	45,100,000	8,900,000	20%	("Potassium chloride production by country," 2019)
Magnesium sulfate heptahydrate	7,300,000	27,000,000	370%	(Fact.MR, 2019; Market Research Future, 2019)*
Iron sulfate heptahydrate	8,200,000	1,400,000	17%	(Reports and Data, 2020)*

Table 9. Share of global production of bioavailable forms of the main minerals required for SCP ramp up. \*Some estimations included price quotes. For a conservative estimate, the most hydrated forms were considered.

Special materials required to produce the necessary chemical equipment must also be considered. This includes noble metals such as platinum for the electrolyzers and solid catalytic materials for the WGS unit. The amount of platinum required for electrolysis depends on the equipment design. For reference, the electrodes of a typical PEM unit contain approximately \$8 worth of material per kW of installed capacity, most of which is from the cost of platinum (James et al., 2018). At a price of \$1500/tr.oz. (James et al., 2018) this would translate to a requirement of nearly 600,000 tonnes of platinum to fulfill the caloric requirements of the world based on PEM electrolysis, in comparison

to the global reserves of 69,000 tonnes (Garside, 2020a) and a yearly production of approximately 200 tonnes (Garside, 2020b). This significant constraint could be somewhat alleviated using other electrolyzers with lower content of noble metals such as alkaline electrolyzers (Sankir and Sankir, 2017), but the energy efficiency would decrease. Platinum is a known limitation to the growth of the water electrolysis industry (Sealy, 2008) and in the last few years a significant amount of research has been directed at finding alternatives to the use of noble metals in electrolyzers, but there are few viable alternatives as of now (Sun et al., 2018). In contrast, the materials typically used to catalyze the WGS reaction include iron, chromium, copper, aluminum and zinc, which are far more common natural resources, and different combinations of these and others can be used (Pal et al., 2018). Thus, this is a significant advantage of the gasification based process in comparison to the electrolysis option.

### **3.3 Number of people fed over time**

The ramp up speed for the scenario in which the global budget for chemical and power production industries can be effectively redirected to fast construction of H<sub>2</sub> SCP factories is shown in Figure 4 for the lower end of the cost range and Figure 5 for the higher one. For this scenario, around 1-2% of the global caloric requirements could be fulfilled at the end of the first year, which translates to approximately 3-10% of the global protein requirements depending on the actual protein content of the SCP produced. The global protein requirements would be covered in about 3-10 years. If the nucleic acids were not removed from the final product this time would be slightly reduced. Please note that the large difference between the lower and higher ends of the electrolysis ramp up speed is due to the effect of including the capital cost of DAC in the lower end (the higher speed end is the lower cost case of free CO<sub>2</sub>).

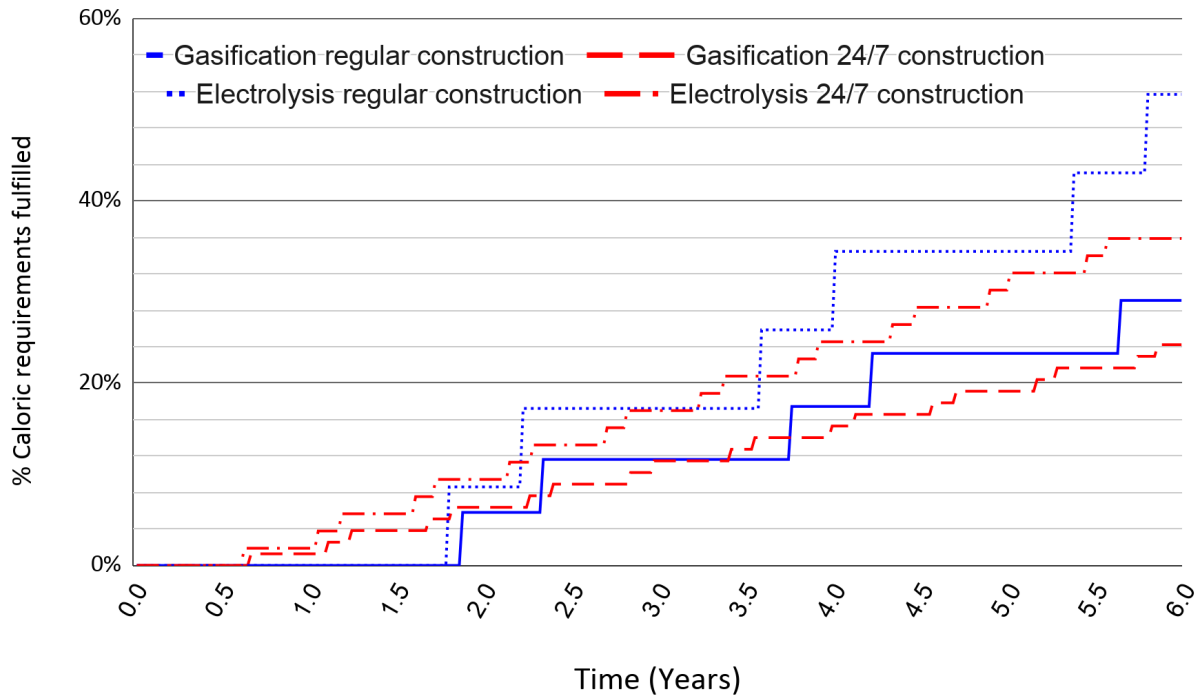

Figure 4. Higher end of the expected ramp up speed of H<sub>2</sub> SCP production in terms of caloric requirements fulfilled over time, obtained from the lower CapEx values. The results shown are for gasification and electrolysis when using the budget of similar industries, including regular and fast construction speeds.

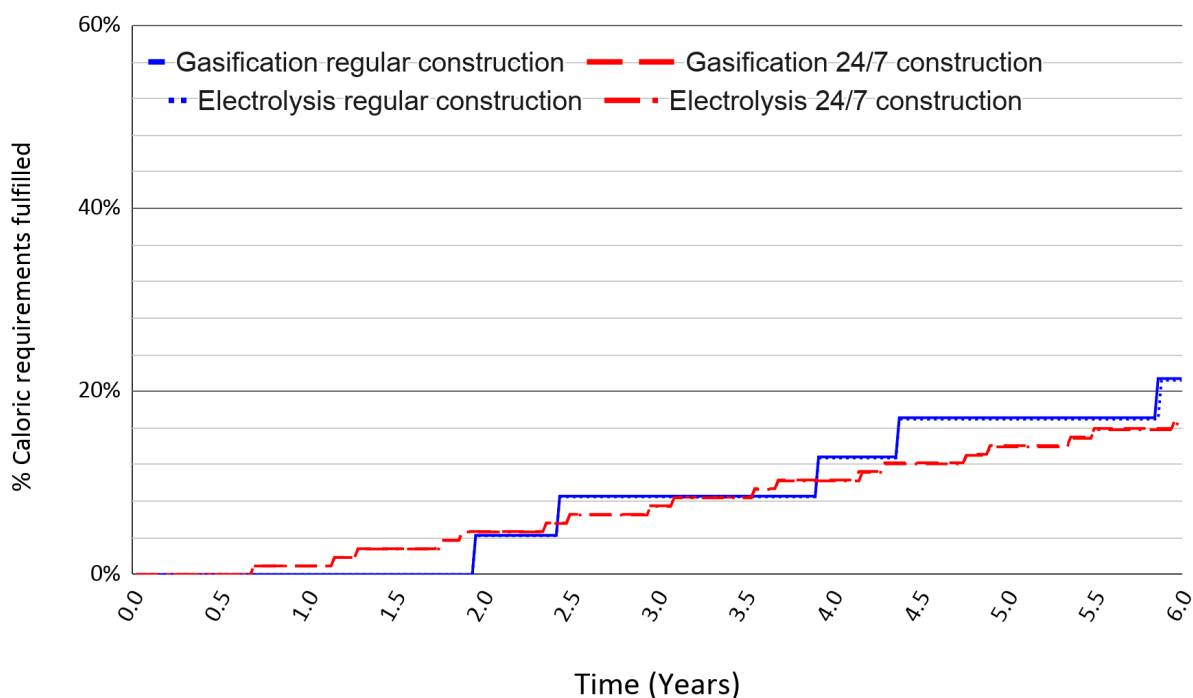

Figure 5. Lower end of the expected ramp up speed of H<sub>2</sub> SCP production in terms of caloric requirements fulfilled over time, obtained from the higher CapEx values. The results shown are for gasification and electrolysis when using the budget of similar industries, including regular and fast construction speeds.

If assuming an unlimited budget and no bottlenecks, the cost of building H<sub>2</sub> SCP factories to fulfill the caloric requirements of humanity in the shortest amount of time (14-15 months to full production) would be 7.1-15.8 trillion USD. For slow construction the cost would be 4.9-10.8 trillion USD, with a time of approximately 2 years and 4 months until full production. However, it should be noted that these would be unrealistic as humans cannot survive only on this food source. In contrast, the global protein requirements could potentially be covered by H<sub>2</sub> SCP even within the duration of the sun-blocking scenario. This would be equivalent to providing at most 19%-31% of the caloric requirements of the population. To do this, the required fast construction budget is estimated around 1.4-4.8 trillion USD depending on protein content, choice of process and plant capital intensity. Figure 6 shows the ramp up speed in terms of the global protein requirements for an average protein content of the SCP and the average of the capital cost ranges, which can be considered a "best estimate" of the ramp up speed. Additionally, the middle of the range of protein content (65%) corresponds with the expected protein content of the Unibio SCP reference after nucleic acid removal.

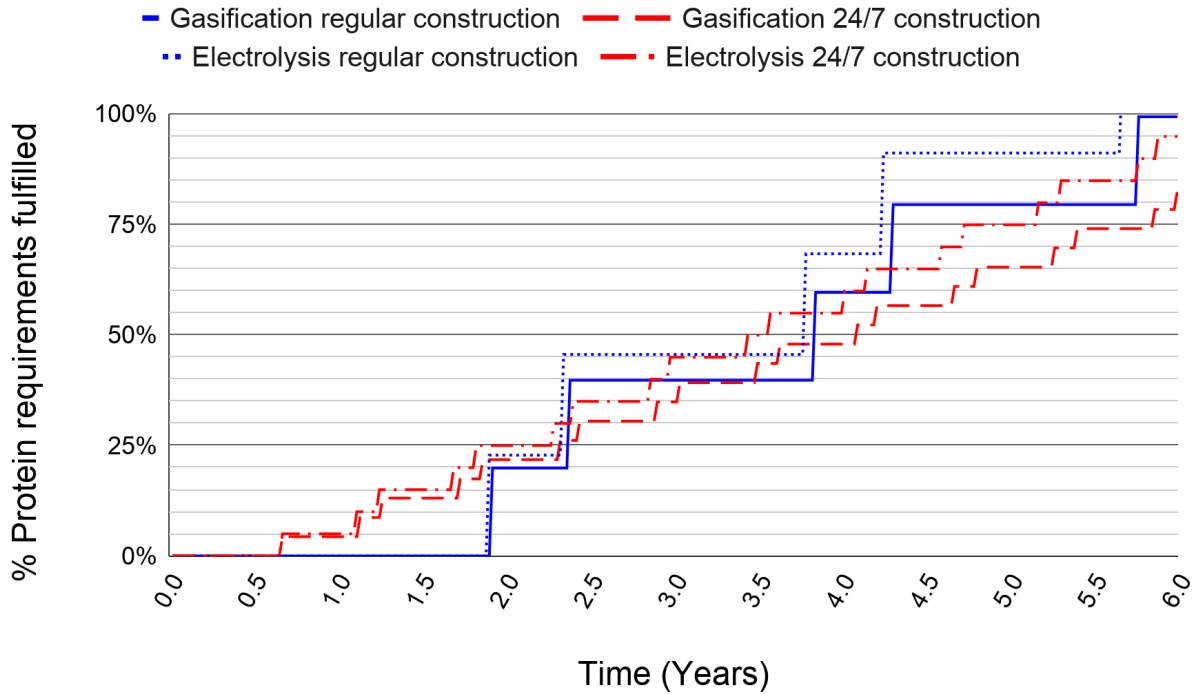

Figure 6. Expected ramp up speed of H<sub>2</sub> SCP production in terms of global protein requirements fulfilled over time, obtained from the averages of the ranges of CapEx values and an average protein content. The results shown are for gasification and electrolysis when using the budget of similar industries, including regular and fast construction speeds.

### 3.4 Economic analysis

The break-even cost of H<sub>2</sub> SCP was calculated for each combination of the considered CapEx and OpEx values. The lowest (low capital and operating cost) and highest (high capital and operating cost) values for each of the two options are broken down in Figure 7. A markup of 100% was then applied to estimate the retail cost of the SCP product, accounting for distribution and other additional costs. We refer to these values as a retail cost instead of price due to the uncertain equilibrium of the market during a catastrophe, which could alter the sale price. The result is shown in Table 10. As can be seen from the difference between Figure 7 and Table 10, using the same markup value for all prices means that the difference between break-even cost and retail cost may considerably differ between the options.

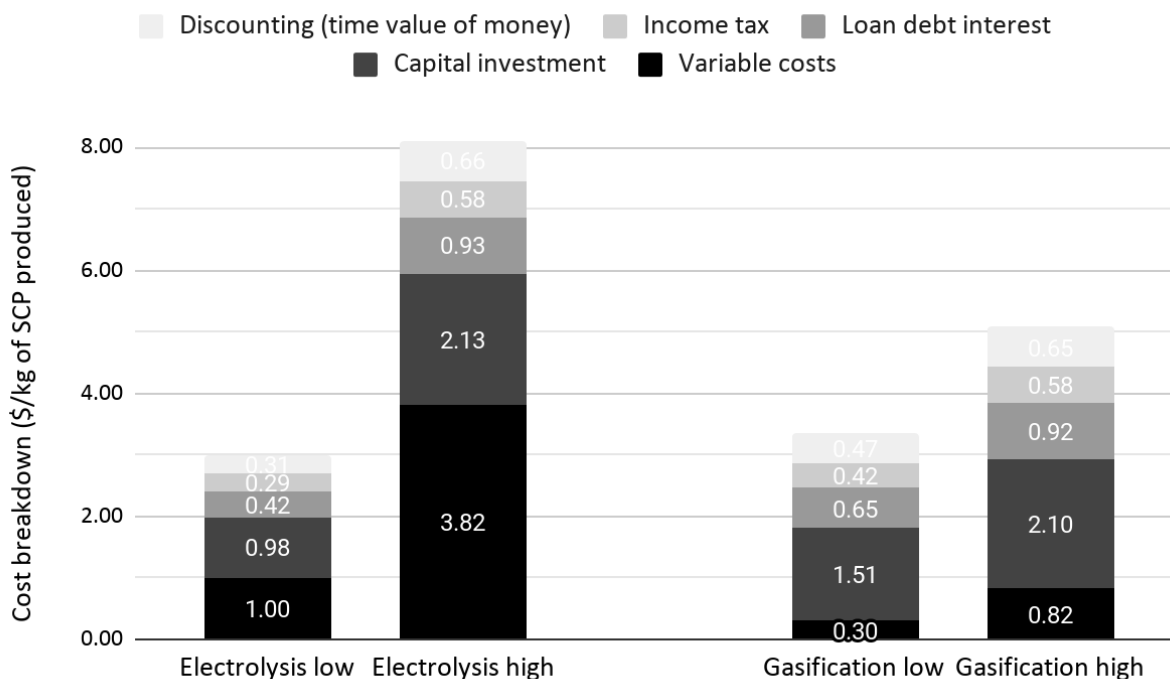

Figure 7. Breakdown of the contributions to the expenditures incurred per unit of H<sub>2</sub> SCP produced (manufacturing cost) for a 6-year project timeline.

	Low CapEx & OpEx		High CapEx & OpEx	
	6 years	20 years	6 years	20 years
Electrolysis	\$6.00	\$4.04	\$16.24	\$12.14
Gasification	\$6.70	\$3.70	\$10.16	\$5.98

Table 10. Retail cost of H<sub>2</sub> SCP for different fast construction cost scenarios in \$/dry kg SCP.

## 4 Discussion

The estimated retail costs for the 6 year proposed production period of very low sunlight are 34%-81% more expensive than their 20 year long counterparts. In a sun-blocking scenario the sunlight would take longer than 6 years to recover to current levels, but factories built later would have fewer years of high value food to operate. There may be some opportunity to operate after the catastrophe, but there would likely be lower demand for the product. Overall, the cost analysis is likely conservative for the first year's worth of factories. Gasification is more positively affected by the longer production period due to its much lower operating costs compared to electrolysis. Electricity cost is a crucial factor for the production cost of electrolysis based SCP production, while availability of CO<sub>2</sub> capture facilities is key for a lower capital cost. Locations with a low

electricity price and presence of industrial sources of captured waste CO<sub>2</sub> should be strongly favored for increased affordability of the product and faster deployment.

The cost estimates in this work are quite conservative for various reasons. Apart from the fact that any possible profits turned in by the SCP plants after the initial 6 years are being ignored, if indeed the plants were built to last for only 6 years, the capital costs could be lowered by building less durable equipment. The growth rate of HOB is higher than methane-oxidizing bacteria, which means that the reactor technology required could be less expensive. Most importantly, many of the technologies involved have not yet reached maturity, so future improvements will likely reduce both capital and production costs.

In comparison with other alternative foods that could be deployed during a sun-blocking catastrophe, H<sub>2</sub> SCP is relatively slow to ramp up. There are other foods such as greenhouse grains, vegetables, etc. in the tropics (Alvarado et al., 2020) and seaweed farming in the ocean among others (Denkenberger and Pearce, 2016, 2015) that could be deployed in such a scenario with a faster production ramp up, but with much lower protein content and quality. This is due to the high resource intensity of HOB technology, requiring a significant amount of specialized equipment and qualified labor. However, H<sub>2</sub> SCP can still play a key role in the resilience of the food system. If over the next few years multiple of these factories are built, whether it is for producing human-grade food or animal feed, that would increase the resilience of the food system during a food shock. Those plants could be easily repurposed to contribute to the human food production during the catastrophe. The changes would be as little as switching from solar PV, one of the lowest cost electricity sources (Eckhouse, 2020; Ellsmoor, 2019; International Renewable Energy Agency, 2019), to the electric network for the previous solar electrolysis plants, or adding an extra purification step to remove nucleic acids for the animal feed plants.

Each of these plants (reference size) available at the start of the catastrophe would mean that up to 620,000 people could have their entire caloric needs covered, or about 2.6 million people could have their minimum protein requirements fulfilled. Having more SCP plants available at the start of the sun-blocking catastrophe would be mathematically equivalent to shifting the ramp up curves upwards, allowing to fulfill more nutritional requirements from the start. Furthermore, the experience of building these plants would reduce the uncertainty in the rapid scale up of many more plants. On the other hand, if the delay before starting the construction of new plants is longer than the proposed 4 weeks, that would be equivalent to shifting the curves to the right, slowing the entire process. One way to ward this off could be having a coordinated plan stipulating the deployment of materials and personnel to the relevant locations in the event of a relevant catastrophic event. This could include a ready-made generalist H<sub>2</sub> SCP front end engineering design package coming from industry or academia, and a collection of pre-approved sites for the plants. More research on how to expedite responses to severe global food crises is required.

The capital required to fulfill the entire human caloric requirements via the fast ramp up of H<sub>2</sub> SCP was estimated at 7.1-15.8 trillion USD. In comparison, the yearly spending of the construction industry amounted to 11.4 trillion USD in 2018 and is projected to keep growing to 14 trillion USD in 2025 (de Best, 2021). If the capital, labor, material, knowledge and production capacity of the sector could be leveraged entirely for fast construction of H<sub>2</sub> SCP facilities without bottlenecks, enough food could theoretically be produced to feed the entire global population in just over 1 year. This is longer than the time that current food reserves would last in a sun-blocking scenario,



estimated at about 6 months (Denkenberger et al., 2019a). In addition, the titanic effort in international cooperation required would be unprecedented.

The electrolysis based production of SCP is strongly limited by the availability of noble metals and current lack of viable alternatives to their use. However, even if it could be ramped up to feed everyone within the desired timeline, the electricity requirement would still be over the current electricity production capacity of the world at 100% duty. Even if all the capacity could be effectively rerouted, operating power plants at maximum load to leverage the entire global electricity production capacity would require significantly more fuel use than the current one. This may be unfeasible, cause significant increase in electricity price and cause substantially more pollution and concomitant negative environmental and health effects given the presumably fossil fuel dependent energy mix. That is without taking into account the loss of the rapidly growing energy sectors reliant on sunlight-based power in a sun-blocking catastrophe, such as solar and wind; nor the energy required to produce the required ammonia and minerals. In comparison, gasification based plants are ostensibly not limited by material availability and their electricity consumption is comparatively low (around 26% of current global consumption when fulfilling caloric requirements). For these reasons, any significant degree of H<sub>2</sub> SCP ramp up would have to be based on gasification to a much higher degree than on electrolysis (or on other options such as SMR if needed). However, industrial production of WGS catalysts would have to be significantly increased. Currently there are around 700 gasification units (Global Syngas Technologies Council, 2018), in comparison to the 12,600 that would be required to fulfill global caloric requirements, or the 2,400-3,900 required to fulfill protein requirements. Further research into ramping up catalyst production may be required.

A range of current electricity prices is used to account for the uncertainty of electricity price. It is likely, however, that a recession would take place during the catastrophe, lowering energy prices. Additionally, if H<sub>2</sub> SCP were to use a significant portion of the global electricity production the electricity price could increase significantly. Presumably this would be more problematic for the electrolysis option than for the gasification one because electrolysis requires a higher share of the global electricity capacity than gasification does for global coal production for the same production capacity of SCP.

The global production capacity of minerals required to feed humanity using SCP is not a limitation, save for magnesium. Most bioavailable minerals are 5-20% in terms of the share of the global production required to feed everyone via SCP as shown in Table 9. Magnesium requirements are higher than the current global production, which means that only part of the caloric requirements could be fulfilled without adding new production capacity of bioavailable magnesium. Current global ammonia production is sufficient to fulfill the global protein requirements via H<sub>2</sub> SCP without installing new capacity, especially since agricultural consumption of fertilizers would be severely diminished.

A key issue is the repurposing of qualified labor needed to operate the plants. An auspicious historical example can be found in World War I USA, where the women freshly entering the workforce with partial training were 75% as efficient as the previous workers and just as or more efficient than them with full training (Turner, 1918). Potentially effective interventions could be for SCP industry experts to write a guide on how to successfully build and operate the plants to streamline retraining of operators and construction workers, commit to providing guidance to relevant workers in a catastrophic situation, and openly discuss lessons learned on how to

technically reach and maintain commercial operation once the sector as a whole has reached large scale viability and maturity.

Other potential bottlenecks could affect the mass scale deployment of H<sub>2</sub> SCP. Among them the ramp up speed of the equipment construction stands out, since even if unlimited budget was available the equipment or the materials required to build it may not be provided sufficiently fast. Both equipment construction and labor retraining are roughly accounted for in the ramp up estimations by making it such that only the budget of similar industries could be effectively rerouted to H<sub>2</sub> SCP deployment. There is also the issue of distribution, since producing enough food does not guarantee that it reaches the people who need it. For example, the current global food production is enough to sustain more than 10 billion people, but still hundreds of millions of people experience starvation (Holt-Giménez et al., 2012). Further inquiry in these issues is essential, and left for future work on the topic of alternative foods for GCR scenarios.

Overall, despite the fact that SCP as an alternative food would not work for all strong food shock scenarios (e.g. those that include disabling of industry (Denkenberger et al., 2019b, 2017)), it is found to be a promising technology for providing a substantial fraction of humanity's protein needs during a severe global food catastrophe. Due to these potential difficulties and the existence of other available alternative foods with lower cost per calorie (Denkenberger et al., 2019a; Throup et al., 2021) and faster production ramp up (Alvarado et al., 2020; Denkenberger and Pearce, 2015; Throup et al., 2021), it does not seem reasonable to recommend ramping up H<sub>2</sub> SCP any further than required to fulfill the protein requirements of the population. At the speed described by Figures 4 and 5 for redirecting similar sectors this could take between 3-10 years, but could be done in just over one year if other industrial sectors could be effectively redirected. For the equivalent production capacity the potential resource bottlenecks around bioavailable nutrients and electricity are not a crucial concern.

## 5 Conclusions

Results show that the expected capital cost for a large scale H<sub>2</sub> SCP production facility built via 24/7 construction is in the ranges of \$5,600-12,400/tpa when based on electrolysis and \$8,700-12,300/tpa when based on coal gasification. The estimated retail cost of the SCP product would be in the range of \$6-16/dry kg.

The ramp up speed of H<sub>2</sub> SCP is lower than that of most other alternative foods for a sun-blocking scenario. If SCP production plants were constructed to produce food before a disaster scenario, however, it would reduce the required alternative food ramp-up during a food shock catastrophe, increasing resilience against these shocks.

Three resource-based bottlenecks that could hinder the deployment of H<sub>2</sub> SCP to fulfill the global caloric requirements were identified. The first two are the limited availability of noble metals and the high electricity use of electrolysis based plants, which make it unlikely that it could be used to produce a very significant percentage of human food in a catastrophe, but these are not an issue for the gasification based process. The third bottleneck is the production of bioavailable magnesium for both electrolysis and gasification. However, this is not a problem if the target

production capacity is not higher than required to fulfill the protein requirements of humanity. Funding is not expected to be a constraint given the high sums of money spent globally on fighting the COVID-19 pandemic.

Other potential bottlenecks are the amount of qualified labor and construction of chemical equipment that could be rerouted from the global industry to creation of new SCP facilities. These are roughly accounted for in the ramp up calculation by making it such that only the budget of similar industries could be effectively rerouted to H<sub>2</sub> SCP deployment. More research is needed on these constraints to further understand the degree to which they would hinder the ramp up of production capacity of H<sub>2</sub> SCP and other alternative foods for GCRs in general.

In conclusion, H<sub>2</sub> SCP could be of considerable use during a global food catastrophe, but will likely only provide a portion of the protein requirements of the population given the contribution of other alternative foods.

## 6 References

- Adjei, A.A., Yamamoto, S., Kulkarni, A., 1995. Nucleic Acids and/or Their Components: A Possible Role in Immune Function. *J. Nutr. Sci. Vitaminol. (Tokyo)* 41, 1–16.  
<https://doi.org/10.3177/jnsv.41.1>
- ALLFED, 2017. ALLFED [WWW Document]. ALLFED. URL <https://allfed.info/> (accessed 7.30.20).
- Alvarado, K.A., Mill, A., Pearce, J.M., Vocaet, A., Denkenberger, D., 2020. Scaling of greenhouse crop production in low sunlight scenarios. *Sci. Total Environ.* 707, 136012.  
<https://doi.org/10.1016/j.scitotenv.2019.136012>
- Aneke, M., Wang, M., 2015. Potential for improving the energy efficiency of cryogenic air separation unit (ASU) using binary heat recovery cycles. *Appl. Therm. Eng.* 81, 223–231.  
<https://doi.org/10.1016/j.applthermaleng.2015.02.034>
- Bailey, R., Benton, T., Challinor, A., Elliott, J., Gustafson, D., Hiller, B., Jones, A., Kent, A., Lewis, K., Meacham, T., 2015. Extreme weather and resilience of the global food system: Final project report from the UK-US taskforce on extreme weather and global food system resilience.  
[https://www.stat.berkeley.edu/~aldous/157/Papers/extreme\\_weather\\_resilience.pdf](https://www.stat.berkeley.edu/~aldous/157/Papers/extreme_weather_resilience.pdf)
- Baker, C., McKenzie, K., 2005. Energy consumption of industrial spray dryers. *Dry. Technol.* 23, 365–386. <https://doi.org/10.1081/drt-200047665>
- Bartels, J.R., 2008. A feasibility study of implementing an ammonia economy.  
<https://doi.org/10.31274/etd-180810-1374>
- Baum, S., Denkenberger, D., Pearce, J., 2016. Alternative foods as a solution to global food supply catastrophes 7, 31–35. <https://hal.archives-ouvertes.fr/hal-02113500>
- Baum, S.D., Denkenberger, D.C., Pearce, J.M., Robock, A., Winkler, R., 2015. Resilience to global food supply catastrophes. *Environ. Syst. Decis.* 35, 301–313.  
<https://doi.org/10.1007/s10669-015-9549-2>
- Baumann, C.T., 2014. Cost-to-Capacity Method: Applications and Considerations. *MTs J.* 30, 49–56.  
[https://www.evcvaluation.com/wp-content/uploads/2019/06/Cost-to-Capacity-Method\\_Applications-and-Considerations.pdf](https://www.evcvaluation.com/wp-content/uploads/2019/06/Cost-to-Capacity-Method_Applications-and-Considerations.pdf)
- Beasley, D., 2020. WFP Chief warns of hunger pandemic as COVID-19 spreads (Statement to UN Security Council) | World Food Programme [WWW Document]. URL

- <https://www.wfp.org/news/wfp-chief-warns-hunger-pandemic-covid-19-spreads-statement-un-security-council> (accessed 5.18.20).
- Betti, F., Heinzmann, T., 2020. COVID-19: How companies are changing track to join the fight [WWW Document]. World Econ. Forum. URL <https://www.weforum.org/agenda/2020/03/from-perfume-to-hand-sanitiser-tvs-to-face-masks-how-companies-are-changing-track-to-fight-covid-19/> (accessed 5.27.20).
- Black, 1984. Cost Engineering Management Techniques. CRC Press.
- Blank, L.T., Tarquin, A.J., 2008. Basics of engineering economy/Leland Blank, Anthony Tarquin. Boston: McGraw-Hill Higher-Education.
- Bostrom, N., Cirkovic, M.M., 2011. Global catastrophic risks. Oxford University Press.
- Burns, S., 2015. Power Costs in the Production of Primary Aluminum [WWW Document]. Steel Alum. Copp. Stainl. Rare Earth Met. Prices Forecast. Met. URL <https://agmetalmminer.com/2015/11/24/power-costs-the-production-primary-aluminum/> (accessed 5.20.20).
- Calysta Inc., 2020. Adisseo and Calysta establish a Joint-Venture to commercialize FeedKind® [WWW Document]. URL <http://www.feedkind.com/adisseo-calysta-establish-joint-venture-commercialize-feedkind/> (accessed 5.23.20).
- Cirkovic, M.M., 2008. Observation selection effects and global catastrophic risks, in: Global Catastrophic Risks. Oxford University Press Oxford, pp. 120–145.
- Claassens, N.J., Sousa, D.Z., dos Santos, V.A.P.M., de Vos, W.M., van der Oost, J., 2016. Harnessing the power of microbial autotrophy. Nat. Rev. Microbiol. 14, 692–706. <https://doi.org/10.1038/nrmicro.2016.130>
- Coupe, J., Bardeen, C.G., Robock, A., Toon, O.B., 2019. Nuclear winter responses to nuclear war between the United States and Russia in the whole atmosphere community climate model version 4 and the Goddard Institute for Space Studies ModelE. J. Geophys. Res. Atmospheres 124, 8522–8543. <https://doi.org/10.1029/2019JD030509>
- Damodaran, A., 2020. Capital Expenditures by Sector (US) [WWW Document]. URL [http://pages.stern.nyu.edu/~adamodar/New\\_Home\\_Page/datafile/capex.html](http://pages.stern.nyu.edu/~adamodar/New_Home_Page/datafile/capex.html) (accessed 5.23.20).
- de Best, R., 2021. Construction industry spending globally [WWW Document]. Stat. Constr. Ind. Spend. Worldw. 2014 2019 Forecasts 2020 2035. URL <https://www.statista.com/statistics/788128/construction-spending-worldwide/> (accessed 2.19.21).
- De Vrieze, J., Verbeeck, K., Pikaar, I., Boere, J., Van Wijk, A., Rabaey, K., Verstraete, W., 2020. The hydrogen gas bio-based economy and the production of renewable building block chemicals, food and energy. New Biotechnol. 55, 12–18. <https://doi.org/10.1016/j.nbt.2019.09.004>
- Denkenberger, D., Pearce, J., Taylor, A.R., Black, R., 2019a. Food without sun: Price and life-saving potential. Foresight 21, 118–129. <https://doi.org/10.1108/FS-04-2018-0041>
- Denkenberger, D., Pearce, J.M., 2014. Feeding everyone no matter what: Managing food security after global catastrophe. Academic Press.
- Denkenberger, D., Sandberg, A., Tieman, R., Pearce, J.M., 2019b. AGI safety and losing electricity/industry resilience cost-effectiveness. <https://forum.effectivealtruism.org/posts/XA8QSCL7wZg73i6vr/cost-effectiveness-of-agi-safety-versus-preparation-for-loss>
- Denkenberger, D.C., Cole, D.D., Abdelkhalig, M., Griswold, M., Hundley, A.B., Pearce, J.M., 2017. Feeding everyone if the sun is obscured and industry is disabled. Int. J. Disaster Risk

- Reduct. 21, 284–290. <https://doi.org/10.1016/j.ijdr.2016.12.018>
- Denkenberger, D.C., Pearce, J.M., 2018. Cost-effectiveness of interventions for alternate food in the United States to address agricultural catastrophes. *Int. J. Disaster Risk Reduct.* 27, 278–289. <https://doi.org/10.1016/j.ijdr.2017.10.014>
- Denkenberger, D.C., Pearce, J.M., 2016. Cost-effectiveness of interventions for alternate food to address agricultural catastrophes globally. *Int. J. Disaster Risk Sci.* 7, 205–215. <https://doi.org/10.1007/s13753-016-0097-2>
- Denkenberger, D.C., Pearce, J.M., 2015. Feeding everyone: Solving the food crisis in event of global catastrophes that kill crops or obscure the sun. *Futures* 72, 57–68. <https://doi.org/10.1016/j.futures.2014.11.008>
- Eckhouse, B., 2020. Solar and Wind Cheapest Sources of Power in Most of the World. Bloomberg.com. <https://www.bloomberg.com/news/articles/2020-04-28/solar-and-wind-cheapest-sources-of-power-in-most-of-the-world>
- EIA, 2020a. Average retail price of electricity [WWW Document]. US Energy Inf. Adm. URL <https://www.eia.gov/electricity/data/browser/#/topic/7?agg=2,0,1&geo=g&freq=M> (accessed 5.20.20).
- EIA, 2020b. Coal Markets [WWW Document]. US Energy Inf. Adm. URL <https://www.eia.gov/coal/markets/> (accessed 5.20.20).
- Ellsmoor, J., 2019. Renewable Energy Is Now The Cheapest Option - Even Without Subsidies [WWW Document]. Forbes. URL <https://www.forbes.com/sites/jamesellsmoor/2019/06/15/renewable-energy-is-now-the-cheapest-option-even-without-subsidies/> (accessed 5.28.20).
- Eurostat, 2019. Development of electricity prices for non-household consumers, EU-28 and EA [WWW Document]. Eurostat. URL [https://ec.europa.eu/eurostat/statistics-explained/index.php?title=File:Development\\_of\\_electricity\\_prices\\_for\\_non-household\\_consumers,\\_EU-28\\_and\\_EA,\\_2008-2019\\_\(EUR\\_per\\_kWh\).png](https://ec.europa.eu/eurostat/statistics-explained/index.php?title=File:Development_of_electricity_prices_for_non-household_consumers,_EU-28_and_EA,_2008-2019_(EUR_per_kWh).png) (accessed 5.20.20).
- Fact.MR, 2019. Magnesium Sulphate Market Forecast (No. FACT4184MR).
- Finnigan, T.J.A., Wall, B.T., Wilde, P.J., Stephens, F.B., Taylor, S.L., Freedman, M.R., 2019. Mycoprotein: The Future of Nutritious Nonmeat Protein, a Symposium Review. *Curr. Dev. Nutr.* 3. <https://doi.org/10.1093/cdn/nzz021>
- Garside, M., 2020a. Platinum metal reserves worldwide by country [WWW Document]. Statista. URL <https://www.statista.com/statistics/273624/platinum-metal-reserves-by-country/> (accessed 5.29.20).
- Garside, M., 2020b. Platinum mine production by country [WWW Document]. Statista. URL <https://www.statista.com/statistics/273645/global-mine-production-of-platinum/> (accessed 5.29.20).
- Glencross, B.D., Huyben, D., Schrama, J.W., 2020. The Application of Single-Cell Ingredients in Aquaculture Feeds—A Review. *Fishes* 5, 22. <https://doi.org/10.3390/fishes5030022>
- Global Syngas Technologies Council, 2018. The Gasification Industry [WWW Document]. Glob. Syngas Technol. Counc. URL <https://www.globalsyngas.org/resources/the-gasification-industry/> (accessed 5.29.20).
- Gnanapragasam, N.V., Reddy, B.V., Rosen, M.A., 2010. Hydrogen production from coal gasification for effective downstream CO<sub>2</sub> capture. *Int. J. Hydrog. Energy, Novel Hydrogen Production Technologies and Applications* 35, 4933–4943. <https://doi.org/10.1016/j.ijhydene.2009.07.114>
- Grand View Research, 2019. Calcium Carbonate Market Size [WWW Document]. URL <https://www.grandviewresearch.com/industry-analysis/calcium-carbonate-market>

- (accessed 5.28.20).
- Henchion, M., Hayes, M., Mullen, A.M., Fenelon, M., Tiwari, B., 2017. Future protein supply and demand: strategies and factors influencing a sustainable equilibrium. *Foods* 6, 53. <https://doi.org/10.3390/foods6070053>
- Holt-Giménez, E., Shattuck, A., Altieri, M., Herren, H., Gliessman, S., 2012. We already grow enough food for 10 billion people... and still can't end hunger. <https://doi.org/10.1080/10440046.2012.695331>
- Humbird, D., Davis, R., Tao, L., Kinchin, C., Hsu, D., Aden, A., Schoen, P., Lukas, J., Olthof, B., Worley, M., 2011. Process design and economics for biochemical conversion of lignocellulosic biomass to ethanol: dilute-acid pretreatment and enzymatic hydrolysis of corn stover (No. NREL/TP-5100-47764). National Renewable Energy Lab.(NREL), Golden, CO (United States).
- International Renewable Energy Agency, 2019. Renewable Power Generation Costs in 2018 [WWW Document]. URL <https://www.irena.org/publications/2019/May/Renewable-power-generation-costs-in-2018> (accessed 5.28.20).
- Ishizaki, A., Tanaka, K., 1990. Batch culture of *Alcaligenes eutrophus* ATCC 17697T using recycled gas closed circuit culture system. *J. Ferment. Bioeng.* 69, 170–174. [https://doi.org/10.1016/0922-338X\(90\)90041-T](https://doi.org/10.1016/0922-338X(90)90041-T)
- James, B.D., Huy-Kouadio, J.M., Houchins, C., DeSantis, D.A., 2018. Mass production cost estimation of direct H<sub>2</sub> PEM fuel cell systems for transportation applications: 2018 update. *Strateg. Anal. Inc.* <https://www.energy.gov/sites/prod/files/2019/12/f70/fcto-sa-2018-transportation-fuel-cell-cost-analysis.pdf>
- Jorgensen, J.B., 2011. Exploiting Microorganisms for Animal Feed Production. The 7th Malaysia International Agro-Bio Business Conference : What Next Agriculture II, Kuala Lumpur, Malaysia. <https://core.ac.uk/download/pdf/13790016.pdf>
- Keith, D.W., Holmes, G., Angelo, D.S., Heidel, K., 2018. A Process for Capturing CO<sub>2</sub> from the Atmosphere. *Joule* 2, 1573–1594. <https://doi.org/10.1016/j.joule.2018.05.006>
- Kreutz, T., Williams, R., Consonni, S., Chiesa, P., 2005. Co-production of hydrogen, electricity and CO<sub>2</sub> from coal with commercially ready technology. Part B: Economic analysis. *Int. J. Hydrog. Energy* 30, 769–784. <https://doi.org/10.1016/j.ijhydene.2004.08.001>
- LaJeunesse, S., 2020. Research team to study food resilience in the face of catastrophic global events | Penn State University [WWW Document]. URL <https://news.psu.edu/story/622541/2020/06/08/research/research-team-study-food-resilience-face-catastrophic-global-events> (accessed 7.30.20).
- Lane, J., 2018. Construction complete at Unibio/Protelux commercial scale methane to protein plant : Biofuels Digest [WWW Document]. URL <http://www.biofuelsdigest.com/bdigest/2018/09/13/construction-complete-at-unibio-protelux-commercial-scale-methane-to-protein-plant/> (accessed 5.23.20).
- Lowey, N., 2020. H.R.6800 - The Heroes Act. <https://www.congress.gov/bill/116th-congress/house-bill/6800>
- Market Research Future, 2019. Global Magnesium Sulfate Market (No. MRFR/CnM/1675-CR).
- Markets Insider, 2020. Coal PRICE Today | Coal Spot Price Chart [WWW Document]. [markets.businessinsider.com](https://markets.businessinsider.com/commodities/coal-price). URL <https://markets.businessinsider.com/commodities/coal-price> (accessed 5.20.20).
- Marlow Foods Ltd., 2001. GRAS NOTIFICATION for MYCOPROTEIN [WWW Document]. URL <http://wayback.archive-it.org/7993/20171031053437/https://www.fda.gov/downloads/Food/IngredientsPackagingLabeling/GRAS/NoticeInventory/UCM266876.pdf> (accessed 7.30.20).

- Martin, J., Burrows, T.K., Pegg, I., 2006. Predicting Construction Duration of Building Projects. Presented at the Shaping the Change: XXIII FIG Congress, Munich. [https://fig.net/resources/proceedings/fig\\_proceedings/fig2006/papers/ts28/ts28\\_02\\_martin\\_etal\\_0831.pdf](https://fig.net/resources/proceedings/fig_proceedings/fig2006/papers/ts28/ts28_02_martin_etal_0831.pdf)
- Matassa, S., Batstone, D.J., Hülsen, T., Schnoor, J., Verstraete, W., 2015a. Can direct conversion of used nitrogen to new feed and protein help feed the world? *Environ. Sci. Technol.* 49, 5247–5254. <https://doi.org/10.1021/es505432w>
- Matassa, S., Boon, N., Verstraete, W., 2015b. Resource recovery from used water: The manufacturing abilities of hydrogen-oxidizing bacteria. *Water Res.* 68, 467–478. <https://doi.org/10.1016/j.watres.2014.10.028>
- Matassa, S., Papirio, S., Pikaar, I., Hülsen, T., Leijenhörst, E., Esposito, G., Pirozzi, F., Verstraete, W., 2020. Upcycling of biowaste carbon and nutrients in line with consumer confidence: the “full gas” route to single cell protein. *Green Chem.* 22, 4912–4929. <https://doi.org/10.1039/DoGC01382J>
- McConnel, M., 2020. S.3548 - CARES Act 116th Congress. <https://www.congress.gov/bill/116th-congress/senate-bill/3548/text>
- McWard, S., 2017. Lanzatech: Pollution to Products! URL <https://www.lanzatech.com/2017/11/16/pollution-products/> (accessed 8.13.20).
- Mittelsteadt, C., Norman, T., Rich, M., Willey, J., 2015. Chapter 11 - PEM Electrolyzers and PEM Regenerative Fuel Cells Industrial View, in: Moseley, P.T., Garche, J. (Eds.), *Electrochemical Energy Storage for Renewable Sources and Grid Balancing*. Elsevier, Amsterdam, pp. 159–181. <https://doi.org/10.1016/B978-0-444-62616-5.00011-5>
- Pal, D., Chand, R., Upadhyay, S., Mishra, P., 2018. Performance of water gas shift reaction catalysts: A review. *Renew. Sustain. Energy Rev.* 93, 549–565. <https://doi.org/10.1016/j.rser.2018.05.003>
- Phosphate rock mining by country [WWW Document], 2019. . Statista. URL <https://www.statista.com/statistics/681617/phosphate-rock-production-by-country/> (accessed 5.28.20).
- Pikaar, I., Matassa, S., Bodirsky, B.L., Weindl, I., Humpenöder, F., Rabaey, K., Boon, N., Bruschi, M., Yuan, Z., van Zanten, H., 2018. Decoupling livestock from land use through industrial feed production pathways. *Environ. Sci. Technol.* 52, 7351–7359. <https://doi.org/10.1021/acs.est.8b00216>
- Potassium chloride production by country [WWW Document], 2019. . Knoema. URL <https://knoema.com/atlas/topics/Agriculture/Fertilizers-Production-Quantity-in-Nutrients/Potassium-chloride-production> (accessed 5.28.20).
- Ravindra, P., 2000. Value-added food: Single cell protein. *Biotechnol. Adv.* 18, 459–479. [https://doi.org/10.1016/S0734-9750\(00\)00045-8](https://doi.org/10.1016/S0734-9750(00)00045-8)
- Reports and Data, 2020. Ferrous Sulfate Market By Product Type, By Grade, By Application And Segment Forecasts (No. RND\_002632).
- Research and Markets ltd, 2020. Ammonia Market - Growth, Trends, and Forecast (2020 - 2025) (No. 4773617).
- Ritala, A., Häkkinen, S.T., Toivari, M., Wiebe, M.G., 2017. Single cell protein—state-of-the-art, industrial landscape and patents 2001–2016. *Front. Microbiol.* 8, 2009. <https://doi.org/10.3389/fmicb.2017.02009>
- Rivett, P., 2019. Construction Starts on the World’s Largest PEM Electrolyser at Shell’s Rheinland Refinery [WWW Document]. REFHYNE. URL <https://refhyne.eu/construction-starts-on-the-worlds-largest-pem-electrolyser-at-shells-rheinland-refinery/> (accessed 5.20.20).
- Rob Smith, 2018. These are the world’s biggest coal producers [WWW Document]. *World Econ.*

- Forum. URL  
<https://www.weforum.org/agenda/2018/01/these-are-the-worlds-biggest-coal-producers/>  
 (accessed 5.14.20).
- Rosenberry, B., 2019. NovoNutrients: Making Aquatic Feeds from Waste Products [WWW Document]. URL  
<https://www.shrimpnews.com/FreeReportsFolder/SpecialReports/NovoNutrientsShrimpFeedsFromWasteProducts.html> (accessed 5.23.20).
- Salt Data Sheet - Mineral Commodity Summaries, 2020. ,  
<https://pubs.usgs.gov/periodicals/mcs2020/mcs2020-salt.pdf>. U.S. Geological Survey.
- Sankir, M., Sankir, N.D., 2017. Hydrogen Production Technologies. John Wiley & Sons.
- Sealy, C., 2008. The problem with platinum. *Mater. Today* 11, 65–68.  
[https://doi.org/10.1016/S1369-7021\(08\)70254-2](https://doi.org/10.1016/S1369-7021(08)70254-2)
- Sefton, B., 2018. NovoNutrients: Food from CO<sub>2</sub>.  
<http://nas-sites.org/dels/files/2018/02/2-2-SEFTON-NovNutrients-NAS.pdf>
- Shepon, A., Eshel, G., Noor, E., Milo, R., 2016. Energy and protein feed-to-food conversion efficiencies in the US and potential food security gains from dietary changes. *Environ. Res. Lett.* 11, 105002. <https://doi.org/10.1088/1748-9326/11/10/105002>
- Shiva Kumar, S., Himabindu, V., 2019. Hydrogen production by PEM water electrolysis – A review. *Mater. Sci. Energy Technol.* 2, 442–454. <https://doi.org/10.1016/j.mset.2019.03.002>
- Short, W., Packey, D.J., Holt, T., 1995. A manual for the economic evaluation of energy efficiency and renewable energy technologies (No. NREL/TP-462-5173). National Renewable Energy Lab., Golden, CO (United States).
- Sillman, J., Nygren, L., Kahiluoto, H., Ruuskanen, V., Tamminen, A., Bajamundi, C., Nappa, M., Wuokko, M., Lindh, T., Vainikka, P., Pitkänen, J.-P., Ahola, J., 2019. Bacterial protein for food and feed generated via renewable energy and direct air capture of CO<sub>2</sub>: Can it reduce land and water use? *Glob. Food Secur.* 22, 25–32. <https://doi.org/10.1016/j.gfs.2019.09.007>
- SolarFoods, 2019. Solein Q&A.  
[https://solarfoods.fi/wp-content/uploads/2019/11/Solein-Q\\_and-A\\_FULL.pdf](https://solarfoods.fi/wp-content/uploads/2019/11/Solein-Q_and-A_FULL.pdf)
- Sönnichsen, N., 2020. Electricity consumption globally [WWW Document]. Statista. URL  
<https://www.statista.com/statistics/280704/world-power-consumption/> (accessed 5.14.20).
- Sönnichsen, N., 2019. Installed electricity capacity globally by source [WWW Document]. Statista. URL  
<https://www.statista.com/statistics/267358/world-installed-power-capacity/> (accessed 5.14.20).
- Southey, F., 2019. Solar Foods makes protein out of thin air: ‘This is the most environmentally friendly food there is’ [WWW Document]. foodnavigator.com. URL  
<https://www.foodnavigator.com/Article/2019/07/15/Solar-Foods-makes-protein-out-of-thin-air-This-is-the-most-environmentally-friendly-food-there-is> (accessed 5.8.20).
- Sulfur production globally by country [WWW Document], 2019. . Statista. URL  
<https://www.statista.com/statistics/1031181/sulfur-production-globally-by-country/>  
 (accessed 5.28.20).
- Sun, X., Xu, K., Fleischer, C., Liu, X., Grandcolas, M., Strandbakke, R., Bjørheim, T.S., Norby, T., Chatzitakis, A., 2018. Earth-Abundant Electrocatalysts in Proton Exchange Membrane Electrolyzers. *Catalysts* 8, 657. <https://doi.org/10.3390/catal8120657>
- Throup, J., Bals, B., Cates, J., García Martínez, J.B., Pearce, J.M., Denkenberger, D.C., 2021. Rapid Repurposing of Biorefinery, Pulp & Paper and Breweries for Lignocellulosic Sugar Production in Global Food Shortages. <https://doi.org/10.31219/osf.io/jns2e>
- Turner, V.B., 1918. Women in industry. *Mon. Labor Rev.* 7, 206–233.  
<https://www.jstor.org/stable/41827308>



- Unibio Group, 2020. Chemical Composition of Uniprotein [WWW Document]. Unibio. URL <https://www.unibio.dk/end-product/chemical-composition-1/> (accessed 5.14.20).
- United Nations, 2019. World Population Prospects 2019: Highlights (No. ST/ESA/SER.A/423).
- U.S. Department of Agriculture, 2016. How many calories are in one gram of fat, carbohydrate, or protein? | Food and Nutrition Information Center | NAL | USDA [WWW Document]. URL <https://www.nal.usda.gov/fnic/how-many-calories-are-one-gram-fat-carbohydrate-or-protein> (accessed 7.30.20).
- U.S. Food and Drug Administration, 2002. GRAS Notices: GRN No. 000091 (Mycoprotein) [WWW Document]. URL <https://www.accessdata.fda.gov/scripts/fdcc/index.cfm?set=GRASNotices&id=91> (accessed 7.30.20).
- Vainikka, P., 2018. Food out of thin air. <https://cdn2.hubspot.net/hubfs/4422035/Solar-Foods-presentation-03-2019.pdf>
- Volova, T.G., Barashkov, V.A., 2010. Characteristics of proteins synthesized by hydrogen-oxidizing microorganisms. *Appl. Biochem. Microbiol.* 46, 574–579. <https://doi.org/10.1134/S0003683810060037>
- World Health Organization, 2004. Food and nutrition needs in emergencies. <https://www.unhcr.org/uk/45fa745b2.pdf>
- World Health Organization, United Nations University, 2007. Protein and amino acid requirements in human nutrition, WHO Technical Report Series 935. ISBN: 92-4-120935-6.
- Worldometers, 2020. World Population Clock [WWW Document]. Worldometers. URL <https://www.worldometers.info/world-population/> (accessed 5.28.20).
- Züttel, A., Borgschulte, A., Schlapbach, L., 2011. Hydrogen as a Future Energy Carrier. John Wiley & Sons.